



# S4C8

## SWITCH

### SINGLE-POLE, FOUR-THROW ABSORPTIVE

<b>Frequency Range (min)</b>	6 – 18	GHz
<b>Insertion Loss (max)</b>	3.4	dB
<b>VSWR (max)</b>	2.0	ratio
<b>Isolation (min)</b>	65	dB
<b>Switching speed (max)</b>	100	nsec
<b>CW RF power, operating (max)</b>	0.5	W

**NOTES:**

DC Bias: +5V +/-0.5V @ 160mA max  
(Standard) -15V +/-3V @ 50mA max

DC Bias: +5V +/-0.5V @ 200mA max  
(-5 option) -5V +/-0.5V @ 60mA max

DC Bias: +15V +/-3V @ 160mA max  
(-12 option) -15V +/-3V @ 50mA max

Control: TTL 0 = Low Loss E1 controls J2 – J1  
(Standard) TTL 1 = Isolation E2 controls J3 – J1  
E3 controls J4 – J1  
E4 controls J5 – J1

**MECHANICAL SPECIFICATIONS:**

Case Style: S4 Outline (Standard logic)  
S4-2 Outline (Two-bit logic)

Finish: Gold plate per MIL-G-45204

Connectors: SMA Female per MIL-C-39012

Bias & Control Pins: ø0.02" x 0.15" long

Weight: 60g max

Mounting: ø0.10" through holes (2) places

Two-bit control:

(-2 option)

E2 E1 Low loss path

0 0 J2 – J1

0 1 J3 – J1

1 0 J4 – J1

1 1 J5 – J1

Absorptive switch: Internal 50Ω terminations at J2, J3, J4 and J5 (in isolation mode).

Switching speed is defined as 50%TTL to 90% (t-on) and 50%TTL to 10%RF (t-off).

**ENVIRONMENTAL SPECIFICATIONS:**

MIL-E-5400, MIL-STD-202, MIL-E-16400

Operating Temp: -55°C to +85°C

Storage Temp: -65°C to +125°C

Humidity: MIL-STD-202F, M103, Cond B

Shock: MIL-STD-202F, M213, Cond B

Altitude: MIL-STD-202F, M105, Cond B

Vibration : MIL-STD-202F, M204, Cond B

Thermal Shock: MIL-STD-202F, M107, Cond A

Temperature Cycle: MIL-STD-202F, M105C, Cond D

**SCREENING:**

Internal Visual per MIL-STD-883, Method 2017

Temperature Cycle: -65°C to +100°C, 10 cycles

Hermetically-sealed switches are fine and gross leak checked per MIL-STD-883, Method 1014.



**OUTLINE CASE STYLE S4**

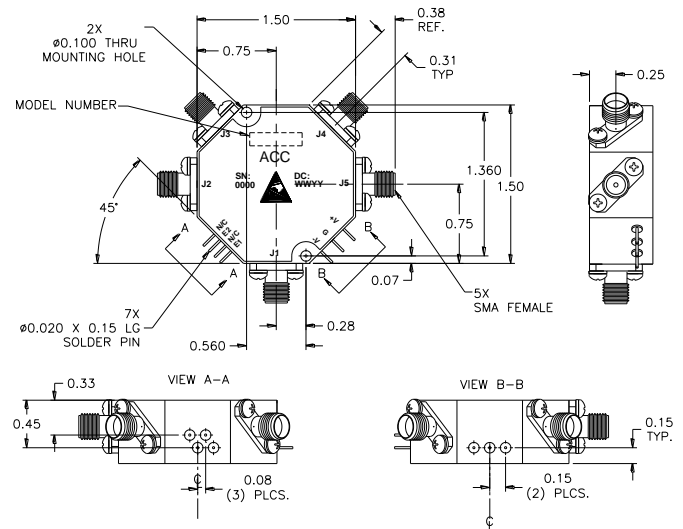

**OUTLINE CASE STYLE S4-2**

**PART NUMBER ORDERING INFORMATION:**

- Add "-RC" suffix: RoHS-compliant
- Add "-5" suffix: +/-5V DC supplies
- Add "-5-RC" suffix: +/-5V DC supplies, RoHS-compliant
- Add "-12" suffix: +/-12V to 18V DC supplies
- Add "-12-RC" suffix: +/-12V to 18V DC supplies, RoHS-compliant
- Add "-2": Two-bit logic control
- Add "-2-RC" suffix: Two-bit logic control, RoHS-compliant
- Add "-2-5" suffix: Two-bit logic control, +/-5V DC supplies
- Add "-2-5-RC" suffix: Two-bit logic control, +/-5V DC supplies, RoHS-compliant
- Add "-2-12" suffix: Two-bit logic control, +/-12V to 18V DC supplies
- Add "-2-12-RC" suffix: Two-bit logic control, +/-12V to 18V DC supplies, RoHS-compliant
- Add "-H" suffix: Hermetic seal (does not apply to RoHS-compliant models)